

Horizontal-Arm CMMs The R Series



The right solution for your measuring task

With nearly 1,000 roller bearing mounted horizontal-arm measuring machines supplied, WENZEL R Series horizontal-arm CMMs have proved successful in daily use, from small businesses to large international corporations in various industries. The CMMs of the R-series are ideal for quick and accurate measurement of individual parts, for serial measurements during production and for the specific analyzes of complex components.

If you are looking for an innovative solution for your entire design process the great variety of designs and options of the R-series provide the right solution for your applications.



1. Automotive industry
2. Railroad industry
3. Aerospace



4. Design
5. Casting
6. Power Generation



7. White goods/
household appliances
8. Construction machines
9. Automotive industry

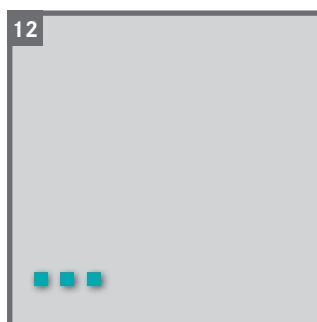

10. Shipbuilding
11. Plastics industry
12. Your application

Machine Concepts

Modular, Multifunctional, Customized

Whether it is needed in direct production or in the measurement lab, the R-Series can be used in various environments. With or without foundation, equipped with active vibration damping or online temperature compensation, WENZEL CMMs prove successful in daily use from small businesses to large international corporations in various industries.



6|7

The RSplus Series

In use everywhere

Universal stand-alone measuring system with guide elements mounted on the side of the base plate.



10|11

The RA Series

Clearing the way for precise results

The floor-level RA can be equipped easily with large components and provides fast and accurate measuring results.



14|15

The RApplus Series

Highest dynamics and precision

The RApplus series meets the highest requirements concerning speed and precision.



18|19

The RAX Series

Precision in large format

The high-performance CMM offers a measuring range which is considerably above average in combination with the highest precision.



20|21

The RUF

The perfect complement

The under-floor measuring arm model RUF is the ideal complement to an RAD and RADplus installation when difficult to access features need to be measured from below.

The R-Series coordinate measuring machines can be installed in stand-alone mode as well as in complex multi systems. Duplex models (e.g. RSD, RAD, RAXD) are supplied to increase the measuring range on the Y axis. The measuring stands can work individually or in a joint coordinate system. We are happy to assist you by sharing our experience and knowledge to build complete measuring rooms starting with planning the foundation work.

22 | 23

Sensors

Heads systems, probes systems, scanner and change racks
The WENZEL R Series can be equipped with a wide range of touch-trigger, scanning and optical probe systems and design tools.

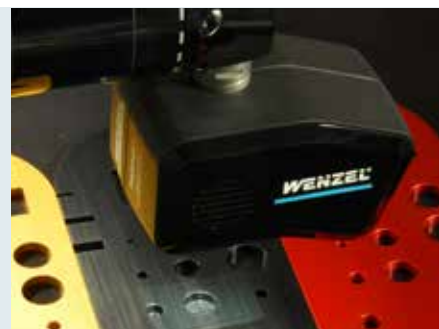

24 | 25

Control units and accessories

Evaluation systems, control units, fixturing systems, styli, etc.



26 | 27

Process solution for styling and design

Ranging from the collection of unknown surface data, to milling following either digital or CAD sources, WENZEL's styling package guarantees that work flows smoothly in the design process.



28 | 29

Proven security concepts

WENZEL offers the right modules and the highest standards whether you need additional signaling systems or access control of the measuring machine using photoelectric sensors.



30

Measuring Software Metrosoft QUARTIS

Convincing measurement results – fast and easy!



The RSplus Series

In use everywhere

The machine concept of RSplus is based on an inherently stable base plate with a side-mounted guide concept. Its flexibility allows RSplus to be easily integrated into existing room concepts. The RSplus allows production-related measurement of typical components such as individual vehicle components, assembly groups, plastic interior parts and other large pieces.

The all-rounder with high application flexibility

The RSplus has three operating modes (CNC, motor, manual) and a variety of development and expansion stages for maximum application flexibility. It is used in measuring centers, on the production floor and in design or in model and mold making.

Flexible for room, building and process changes

This RSplus allows easy and flexible integration into existing rooms and building concepts. In the case of structural engineering or process-related changes it can be adapted easily.

Long working life

The sophisticated machines with wear-resistant design and optimized components make the RSplus a real long-term runner.

Easy to maintain

The optimum accessibility allows quick maintenance operations and reduced downtime.

Easy to use and variable types of applications

The RSplus can be operated very easily as a CNC machine and manually. This has proven successful particularly in tool and mold making as well as in numerous design and styling studios. Mobile control elements and the lightweight design provide maximum flexibility and ergonomics.

Precision through proven technology

Combined bearings, guide and drive technology and the use of carbon fiber composite guarantee the proven mechanical accuracy of RSplus.

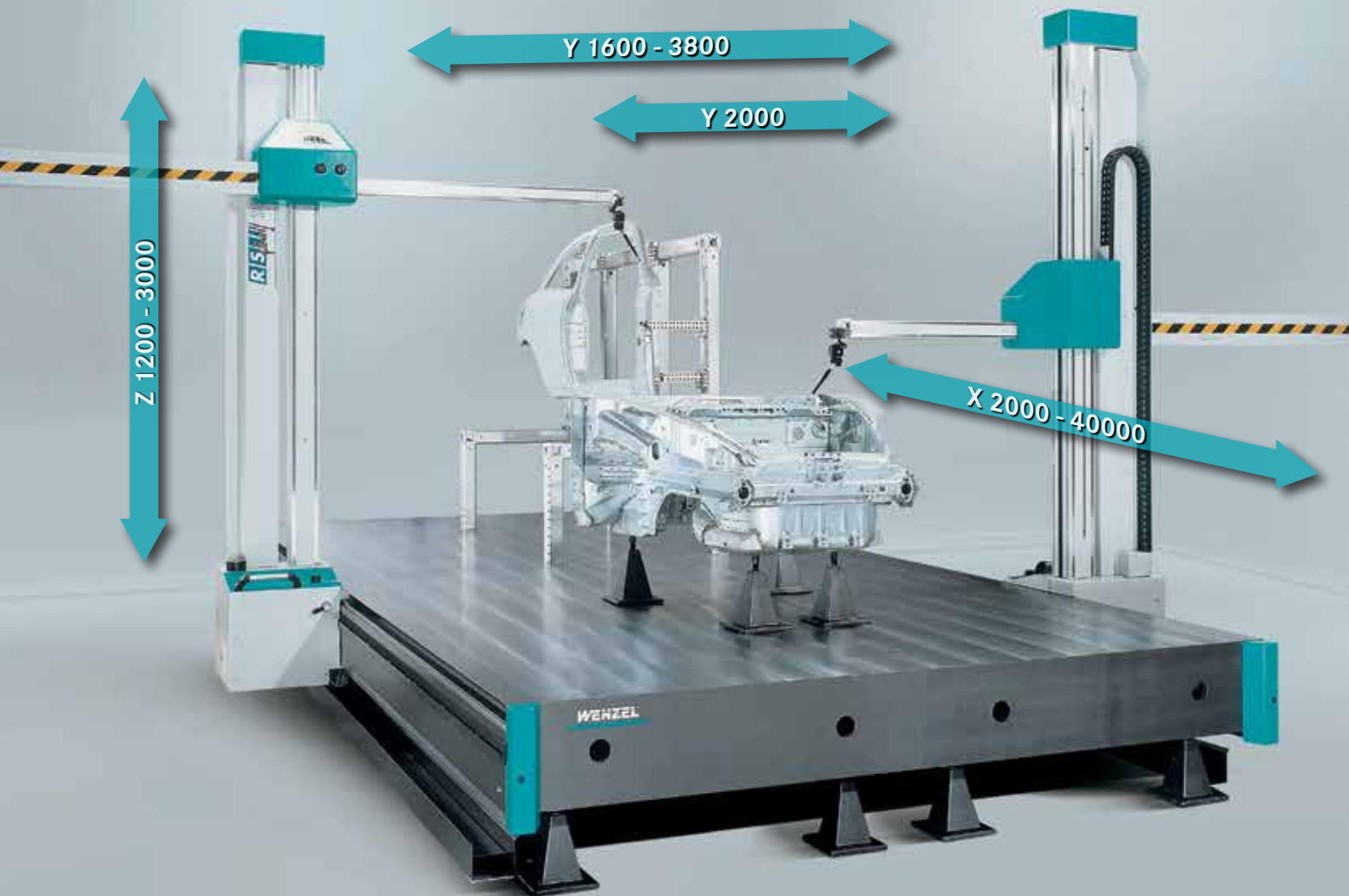

All machines are available in cast iron up to X = 40.000 mm, in 500 mm increments, other Y-Z ranges are available on request. For technical information, please refer to the respective data sheet.

Flexible applicable

The RSplus can be integrated flexibly into an existing room concept or can be moved to a new location if needed. It can be used very easily as a CNC machine or manually and can be equipped with active vibration damping.



WENZEL Präzision GmbH, Wiesthal



Volkswagen Osnabrück GmbH



The RA Series

Clearing the way for precise results

The floor-level base plates on which the guide systems are mounted are characteristic for the RA series. This design allows easy and quick equipping from heavy components up to complete vehicles. Whether as a single unit or as a complex multi system, the RA CMM provides the required results accurately, reliably and fast.

Floor level access from all sides

The floor-level base plate and the enclosed guide ways allow quick loading and easy positioning of the work pieces. The unit is accessible in a barrier-free way.

Proven technology for precise results

The combination of linear guides, roller bearings and the carbon fiber composite material provide friction and form-fitted transmission. This provides an optimized ratio of movement and precision.

Competence begins with planning

RA measuring machines are used by many customers worldwide in stand-alone mode as well as in complex multi systems. We are happy to assist you by sharing our experience and knowledge to build complete measuring rooms starting with planning the foundation work.

High system efficiency

Our modular and continuous controllers, bearings, drive systems and specially protected components ensure a long lifetime of the system even under high stress.

Varied applications and expansion capabilities

Easy accessibility makes RA an ideal system for work pieces and assemblies which are difficult to handle. Through its modular design, the systems can be easily extended and upgraded to the latest software and hardware version.

Ergonomics in operation and equipping

The user-optimized design of the RA series ,such as mobile control units and its security options, make the system a user-friendly and work safe equipment.



All machines are available in cast iron up to X = 40.000 mm, in 500 mm increments, other Y-Z ranges are available on request. For technical information, please refer to the respective data sheet.

Clearing the way for precise results

Whether it is used as single unit, as a duplex version or as a complete measurement concept with integrated under-floor measuring machines, the CMMs of the RA series prove themselves due to their easy accessibility for work pieces and assemblies which are difficult to handle.



Adam Opel AG, Rüsselsheim

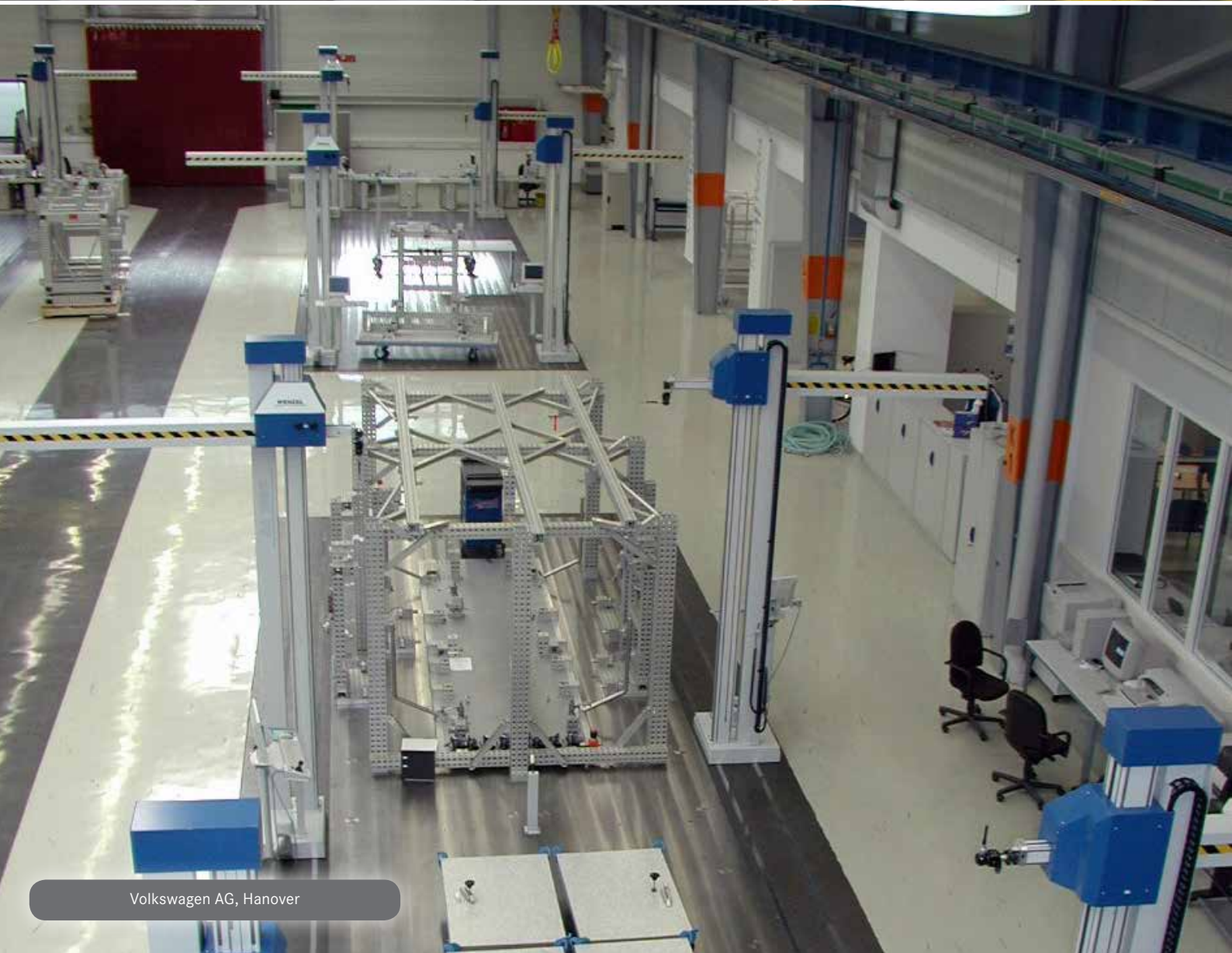

Volkswagen AG, Hanover



BMW AG, Werk Munich



Rolls-Royce Motor Cars Limited, West Sussex

The RAplus Series

Highest dynamics and precision

Like the RA series, the RAplus is mounted on floor-level base plates and allows an easy and quick loading, from heavy components up to complete vehicles. With its very high dynamics, the RAplus performs measurement tasks in the shortest possible time while maintaining its accuracy.

Dynamic drive technology and high precision

Combined bearings and guide technology and the use of carbon fiber composite materials guarantee the high mechanical precision, rigidity and temperature stability of RAplus. Its special drive technology is responsible for additional momentum.

Floor-level access from all sides

The floor-level construction allows easy equipping of the system. In addition, barrier-free access is possible. This minimizes the time required for set-up and retooling of the machine.

Competence begins with planning

RAplus measuring machines are used by many customers worldwide in stand-alone mode as well as in complex multi systems. We are happy to assist you by sharing our experience and knowledge to define processes and measuring rooms.

High system efficiency

Our modular and continuous controllers, bearings, drive systems and specially protected components ensure a long lifetime of the machine even under high dynamic and mechanical stress.

Ergonomics in operation and equipping

The user-optimized design of the RAplus series such as mobile control units and its security options make the system a user-friendly and work safe equipment.

Fast and accurate results

The RAplus proves itself due to its high measuring productivity and precise measurement results. It can be directly integrated into the process chain through suitable stages of development.

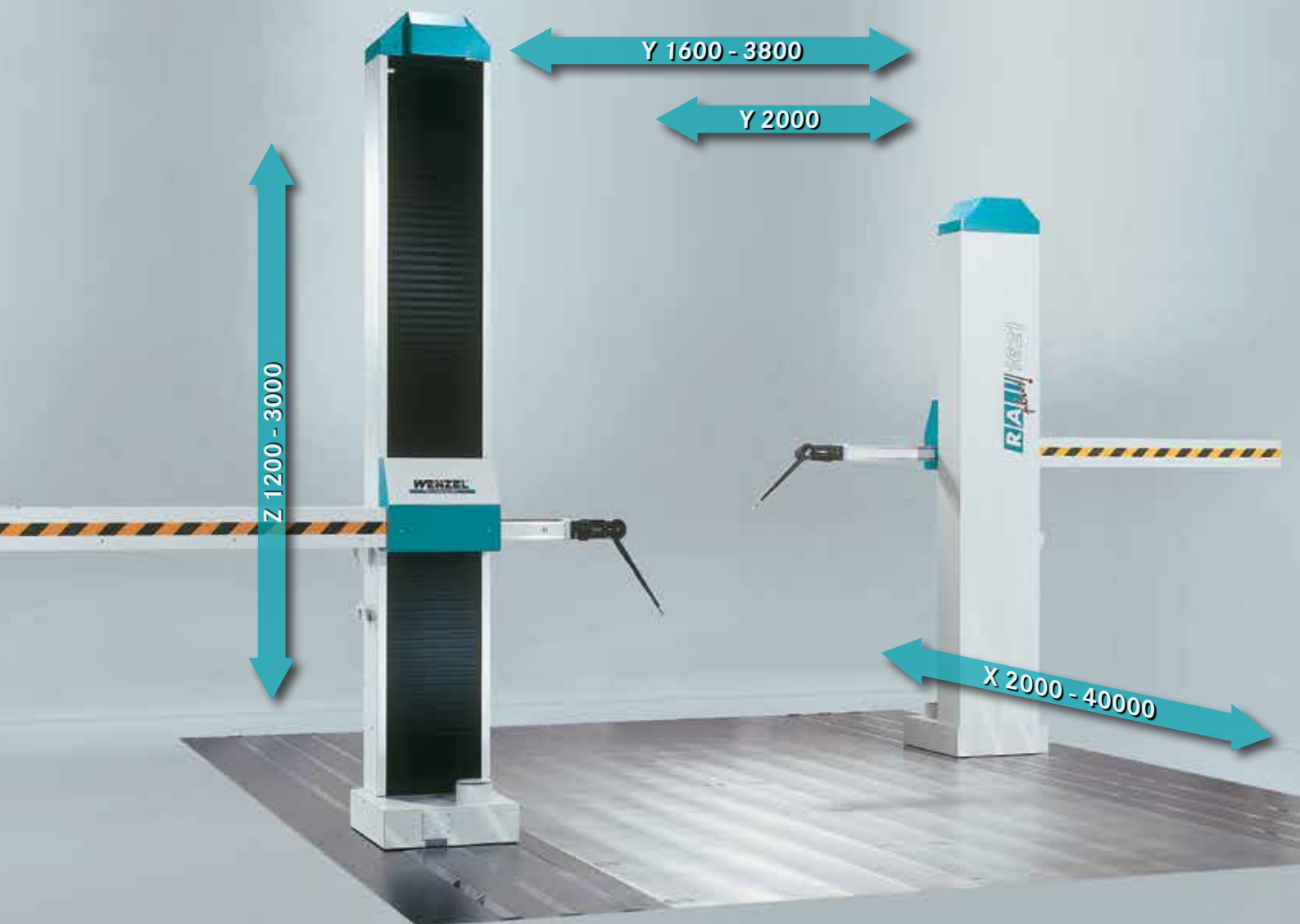

All machines are available in cast iron up to X = 40.000 mm, in 500 mm increments, other Y-Z ranges are available on request. For technical information, please refer to the respective data sheet.

Highest dynamics and precision

The guide unit of the Z-axis with optimal weight ensures maximum speed and acceleration for extremely short processing times.



WENZEL Präzision, Wiesthal



Volkswagen AG, Wolfsburg
RAX-Series, more information on page 18



BMW AG, Leipzig



Daimler AG, Bremen

The RAX Series

Precision in large format

The RAX is the latest CNC horizontal-arm measuring machine of WENZEL and is specifically designed for the needs of the automotive industry. The RAX was designed especially for the very precise measurement of large-volume components. High rigidity and a superior quality drive system guarantee high precision measurement results.

Largest measuring range

The RAX has a wide measuring range up to 3100 mm on the Z-axis. Measurement begins just above the base plate, regardless of the mounting position of the probe. The mirror image construction of the measuring stand in a duplex version, allows optimal use of the X-axis measuring range.

Varied equipment and applications

Mobile control units are optionally available for maximum flexibility and ergonomics. The familiar additional options for WENZEL CMMs, such as the active dynamic temperature compensation or active pneumatic vibration damping are also available for the new RAX.

Integrated processing and control unit

The mobile computer and control unit is thermally enclosed, so that the heat radiation of the equipment is safely discharged from the machine components. Their integration into the system design and the fitted system interface technology becomes a trend-setter for all types of sensors.

Easy to maintain

Relevant system components such as controllers, computer and maintenance-related connections are easily accessible and integrated into the design of the system.

High system efficiency

The use of wear-resistant and optimized components and machine elements as well as the fully automatic lubrication of axes ensure a long lifetime of the machine even under high stress.

Ergonomics in operation and equipping

Mobile control units and its security options make the RAX a user-friendly and safe work equipment. The floor-level construction allows easy equipping of the system. In addition, barrier-free access is possible. This minimizes the time required for set-up and retooling of the machine.

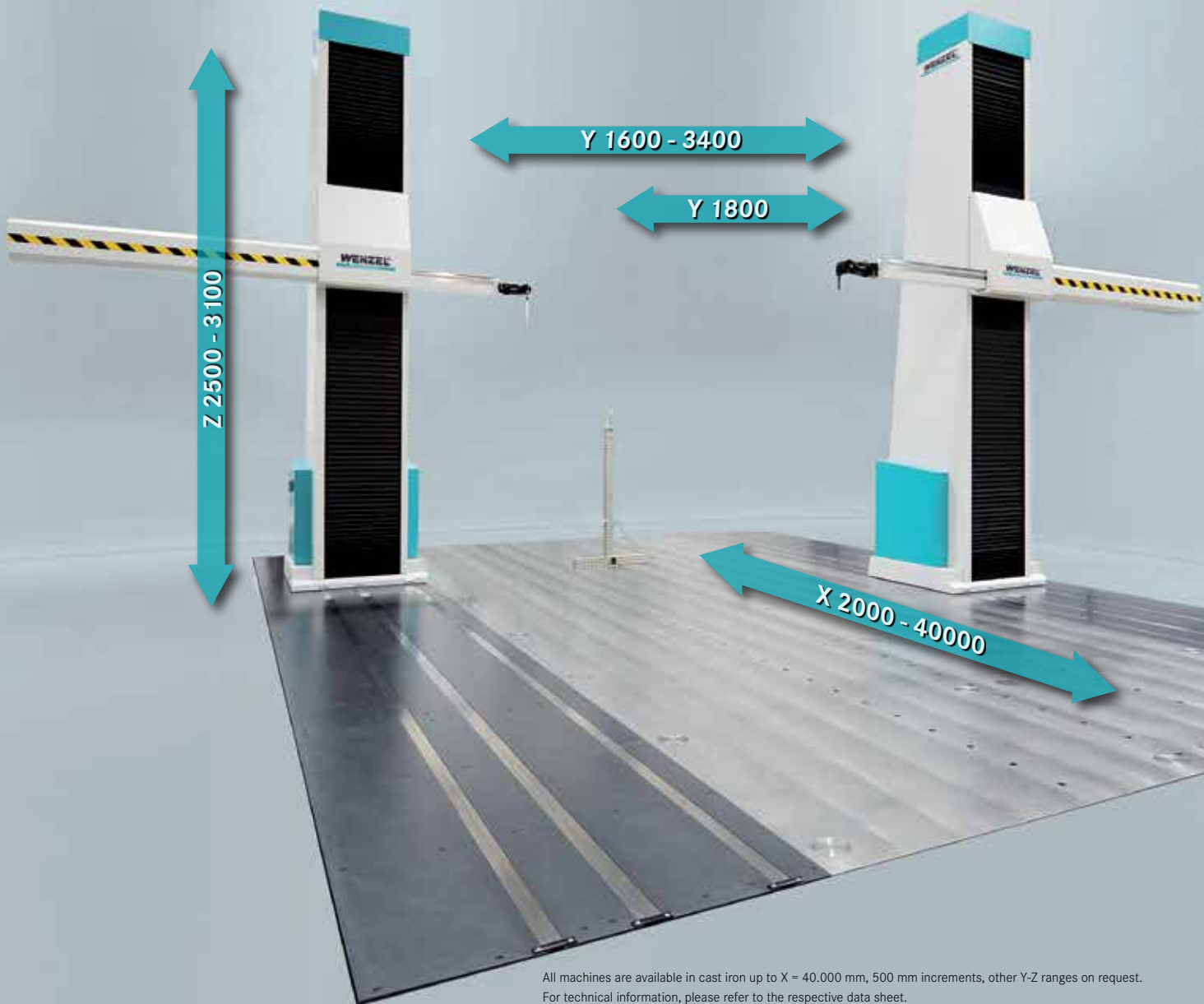

All machines are available in cast iron up to X = 40.000 mm, 500 mm increments, other Y-Z ranges on request.
For technical information, please refer to the respective data sheet.

Highest precision for large parts

Due to their special construction, the usable measuring range already begins just above the base plate, depending on the probe system. With its very high Z-axis, the RAX has an extremely wide measuring range. High rigidity and an ideal drivability guarantee the highest possible precision.

The RUF

The perfect complement

The under-floor measuring arm model RUF is the ideal complement to an RAD and RADplus duplex installation when difficult to access features need to be measured from below. The arm is available in manual or CNC models. The measuring range of the RUF depends on the selected RAD or RAD Plus machine. The measuring stands can work individually or in a joint coordinate system, in a collision protected and synchronous way.

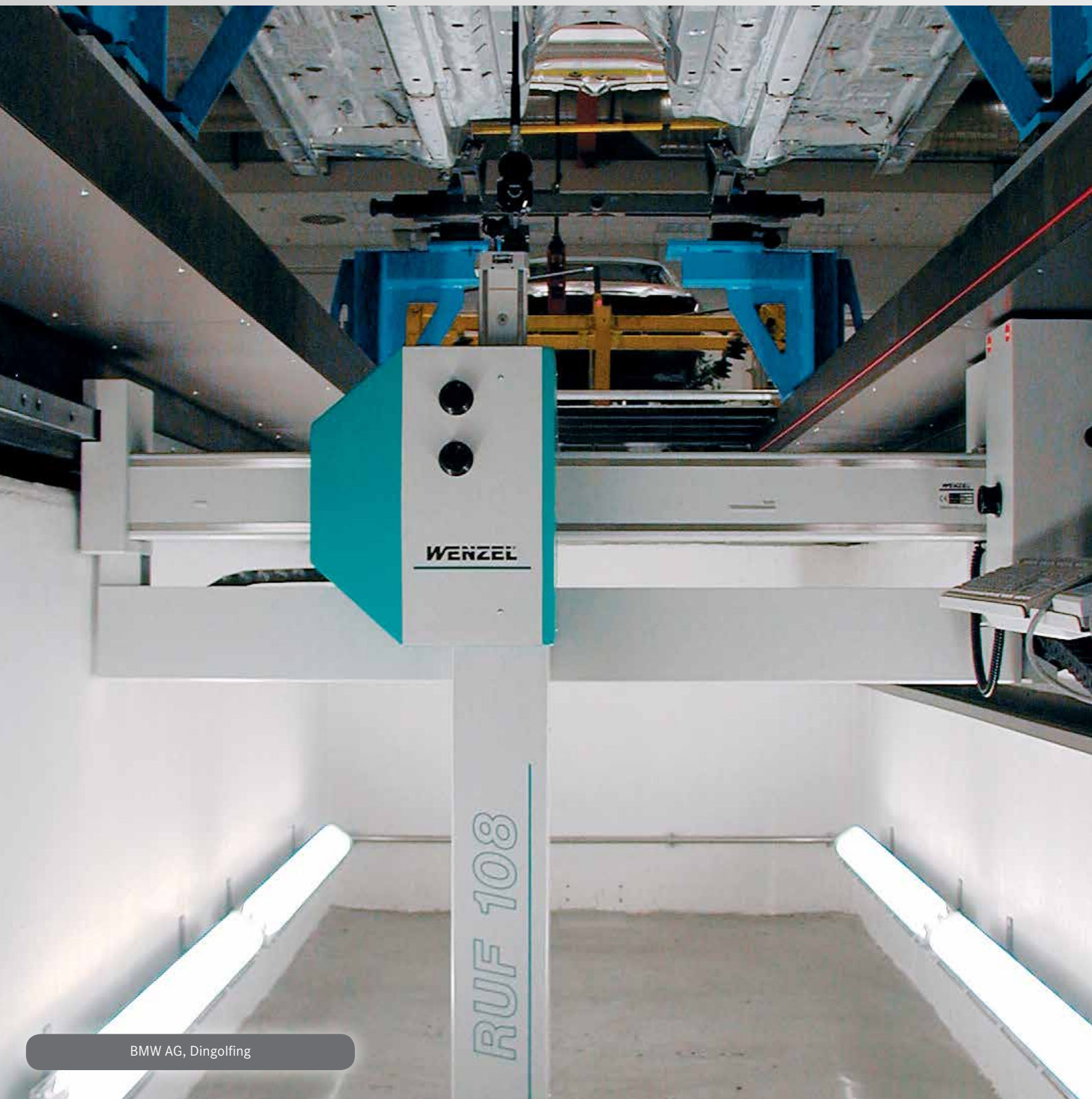



Heads systems, probes systems, scanner and change racks



The R-series can be equipped with manual and motorized index able probe heads and servo positioning heads combined with an extensive range of touch-trigger, scanning and optical measurement systems. In addition, the WENZEL drilling and milling heads for applications in design studios are available.



Universal mounting head

The mounting head allows the mounting of probe systems and marking tools for all axial directions in a fast, secure and user-friendly way.



TP20 probe

Touch trigger probe. Extremely robust and flexible touch trigger probe.



TP200 probe

Highest precision touch probe with stylus change modules. Styli of up to 100 mm can be used.



PH10T/PH10M motorized indexing head

Automatically indexable probe head in 7.5° increments. Extensions of up to 300 mm possible.



SP25M probe

The most compact and versatile probe system for scanning on a global scale.



SP600 probe

A universal robust probe with scanning functions. Ideal for scanning forms and fine surface details.



PHS servo positioning head

Can be swiveled continuously. Minimum probe calibration efforts. Extensions of up to 750 mm possible.



WENZEL SHAPETRACER

The 3D Line Scanner WENZEL SHAPETRACER changes your coordinate measuring machine into the ideal tool to record and handle point clouds. Perfect for tool and die making, design model construction and anyone who needs to record and work on surfaces and outlines of physical objects.



PHOENIX

The optical 3D sensor PHOENIX captures geometry elements and surfaces on different materials in only one working cycle and can be used in combination with tactile probes.

The accessories illustrated here are a small selection from our extensive product range. For more information, please contact your local WENZEL representative.



ACR2 Autochange rack

ACR2 can store up to six probe extensions or probe adaptors. It makes a change of probe extensions or probe adaptors possible so that the measuring tasks do not have to be carried out manually.



MCR20 Stylus change rack

Module change rack enabling automated changing of TP20 stylus modules. The MCR20 module changing rack can store up to six TP20 probe modules for automatic changing under measurement program control.



SCR200 Stylus change rack

The SCR200 provides automatic, high speed changing between up to six TP200 stylus modules. The SCR200 is powered by the separate probe interface, PI 200, and provides features to facilitate safe stylus changing.



ACR3 - FCR25 Stylus change rack

The ACR3 is a four port unit, two can be linked together so that eight different probes or extensions can be stored in the rack - sufficient for any measurement task. FCR25 is a flexible change rack for automated changing of SP25M scanning and touch-trigger modules.

Control units and accessories

Precision in detail

Of course, you can also obtain evaluation systems, control units, fixturing systems and styli from WENZEL. The right accessories are our icing on the cake.

Manual evaluation system

- WPZ 100 digital counter
- PC system
- WENZEL Software
- Computer trolley, small size

MOT/CNC design

- Controller
- Control panel
HT400/HT400 RC
- PC system
- WENZEL Software
- Computer trolley, large size



Modular fixturing systems for 3-coordinate measuring technology

Depending on application requirements, the operating time and the type of material of the component to be clamped, WENZEL offers targeted and cost-effective solutions.

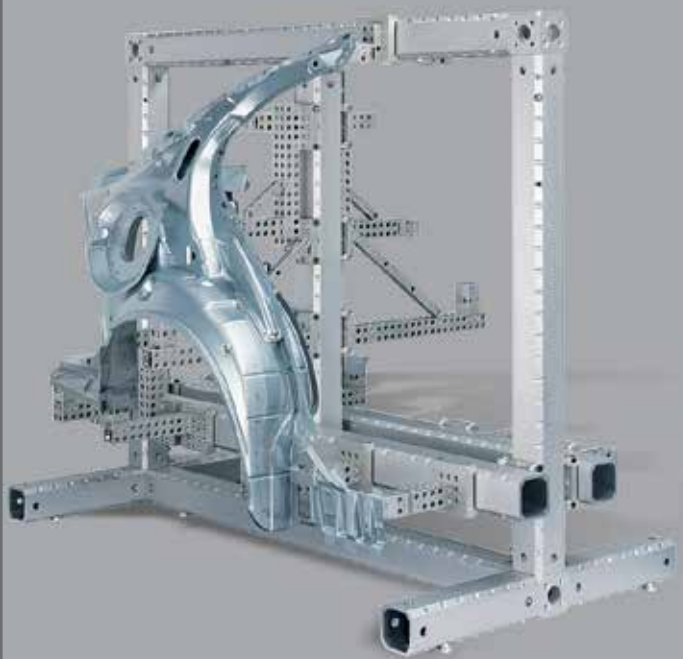

The accessories illustrated here are a small selection from our extensive product range. For more information, please contact your local WENZEL representative.



HT400

Standard teach pendant, non-wireless

HT400 RC

Wireless teach pendant including receiver. The ergonomic design provides multi-functional and comprehensive CMM operation functions. Cross-layer lifetime without charging gear possible.



Tablet PC with WLAN

Portable PC for operating the evaluation software – allowing increased mobility of the operator.



Styli

Extensive range of stylus inserts for every application.



Mobile holder

23" LED flat screen mounted on a rotatable mount to the machine frame. Keyboard with integrated trackball.

Styling Package

Revolutionizing the design process

The design process, from the planning to the realization of the actual model, is made up of a combination of many different steps. To achieve optimal results both software and hardware have to work together perfectly. From the collection of unknown surface data, to milling from either digital or CAD sources, WENZEL's styling package offers the perfect working cycle. The WENZEL Design Package is rounded off by its Milling Heads DMH 200 and Excalibur. Milling programs can be produced quickly and easily by either measuring machine data or by using external CAD sources.



Milling and drilling head DMH 200

For milling in soft materials (foam, clay, ...) spindle capacity 200 watt, max. speed 7000 rpm, convertible to CMM universal mounting head.



2-Axes-CNC milling and drilling head Excalibur

Fully automatic milling plus drilling of models and components, in studio and workshop materials i. e. clay, foam and plastic. Due to its large swivel range (A-Axis +/- 105° A-Axis +/- 170°) and smooth continuously variable positioning, it is possible to access a component or model automatically from 5 sides. Max. speed 5600 rpm.

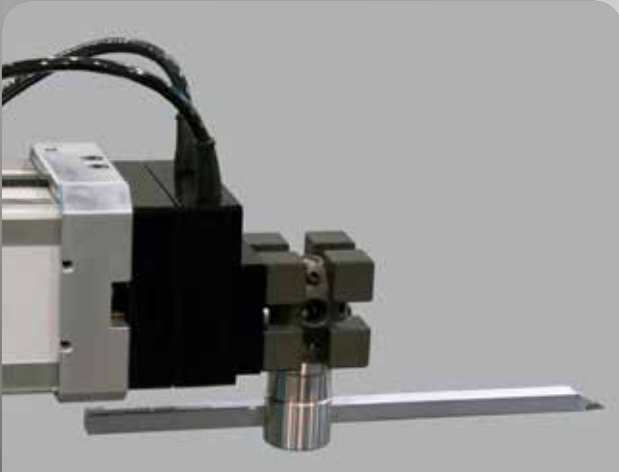

Marking tools

The manual mode of the R-Series allows the marking of clay models and molds in the design area. The proper marking tool is necessary to perform the existing tasks effectively.

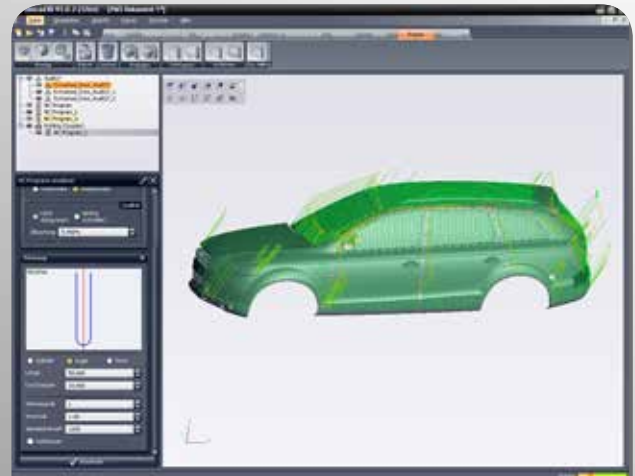

Software DesCAD3D – The visible benefit

DesCAD3D is a powerful tool for modelers and designers. All tasks in the design process are handled by the software. Essential elements of DesCAD3D are the digitizing of geometric elements and surfaces on work pieces and models with touch triggers, optical and multipoint scanning sensors. The system enables users to generate milling programs even for non-WENZEL controllers.



Proven security concepts

Your safety and comfort extra

WENZEL offers the right modules and the highest standards for additional signaling systems or access control of the measuring machine using photoelectric sensors and much more. This ensures the right modules for maximum operator safety and ease of use.

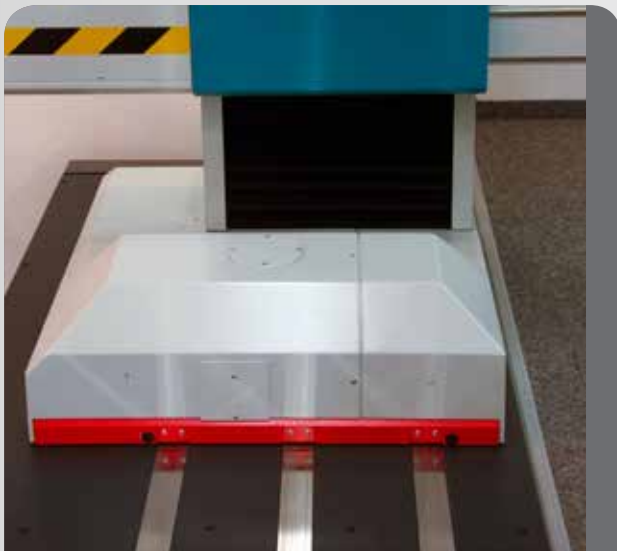

Switching boards for RA and RAplus

Additional collision protection in the X-axis on RA and RAplus machines.



Signal tower

To display errors, 'in tolerance', end of program, etc.



Safety mats

When stepping onto the mat, the machine will stop displaying the error message 'emergency stop'. The mat can also be mounted vertically.



Additional emergency stop on the milling head (Excalibur)

The emergency stop is located directly on the cutter head very close to the tool.

Collision protection - crane interlock

The crane can only travel in the range of the measuring machine, when the CMM is at an end position and vice versa. This is monitored by limit switches.

Safety edges (bumper) at the end of the Y-cover

Additional emergency stop

Safety mats

Access control of the measuring machine by light barriers

Measuring Software Metrosoft QUARTIS

Convincing measurement results – fast and easy!

With Metrosoft QUARTIS, WENZEL Metromec introduces a new software generation into the market. Metrosoft QUARTIS is the first measuring software using the trend-setting Microsoft® Office Fluent™ user interface. Metrosoft QUARTIS is based on the knowledge acquired over decades of one of the most successful measuring software providers worldwide. The result is measuring software with a clear, flexible and results-orientated workspace that reduces distraction for users so that they can focus on their work. Convincing measurement results can now be generated even faster and easier.

Measure against nominal CAD data

Seamless integration of free-form

- Measure surface, point and edge point against nominal CAD data
- Determine nominal values by projection onto CAD model
- Trimming edge and 3D profiles with automatic point distribution
- Bestfit alignment with combination of geometric and free-form elements
- Graphical display of the position deviation
- Immediate display of measurement results in labels
- Surface Profile with or without reference as well as with unilateral and equilateral tolerance zone

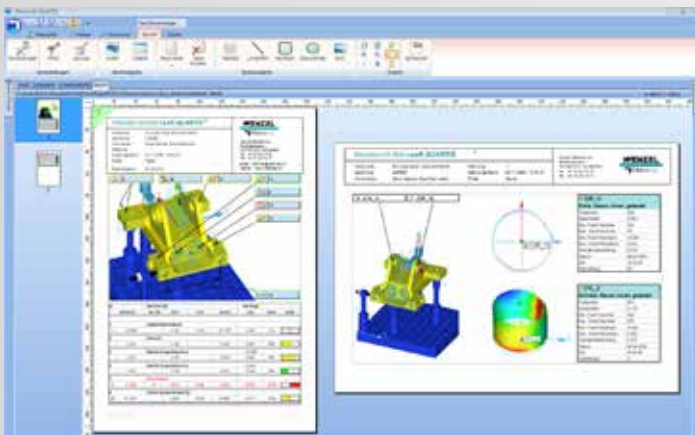
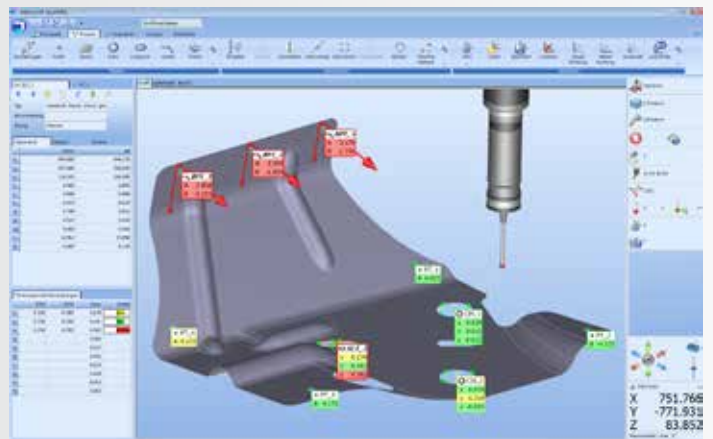

Vivid measuring reports

Present your results

- Free designing – report generator
- Library of templates
- Header fields
- Graphics with configurable data boxes
- Table with configurable lines
- Insert comments and images
- Powerful drawing tools
- Element graphics with colored display of deviations
- Display of tolerance zones
- Gradients for size deviations
- CAD functionality in report
- Configurable languages and units
- PDF, ASCII and Excel file output

We are there for you WENZEL worldwide

WENZEL Group GmbH & Co. KG is one of the leading manufacturers of industrial metrology solutions. The wide range of WENZEL products includes solutions in the fields of coordinate measuring machines, gear metrology, computed tomography

and optical high speed scanning. Founded in 1968 as a family business, WENZEL Group combines tradition with innovation, and relies on values such as reliability, trust and respect for the environment. Subsidiaries as well as sales and service partners

worldwide represent the company in more than 50 countries. The WENZEL Group employs more than 630 people worldwide.

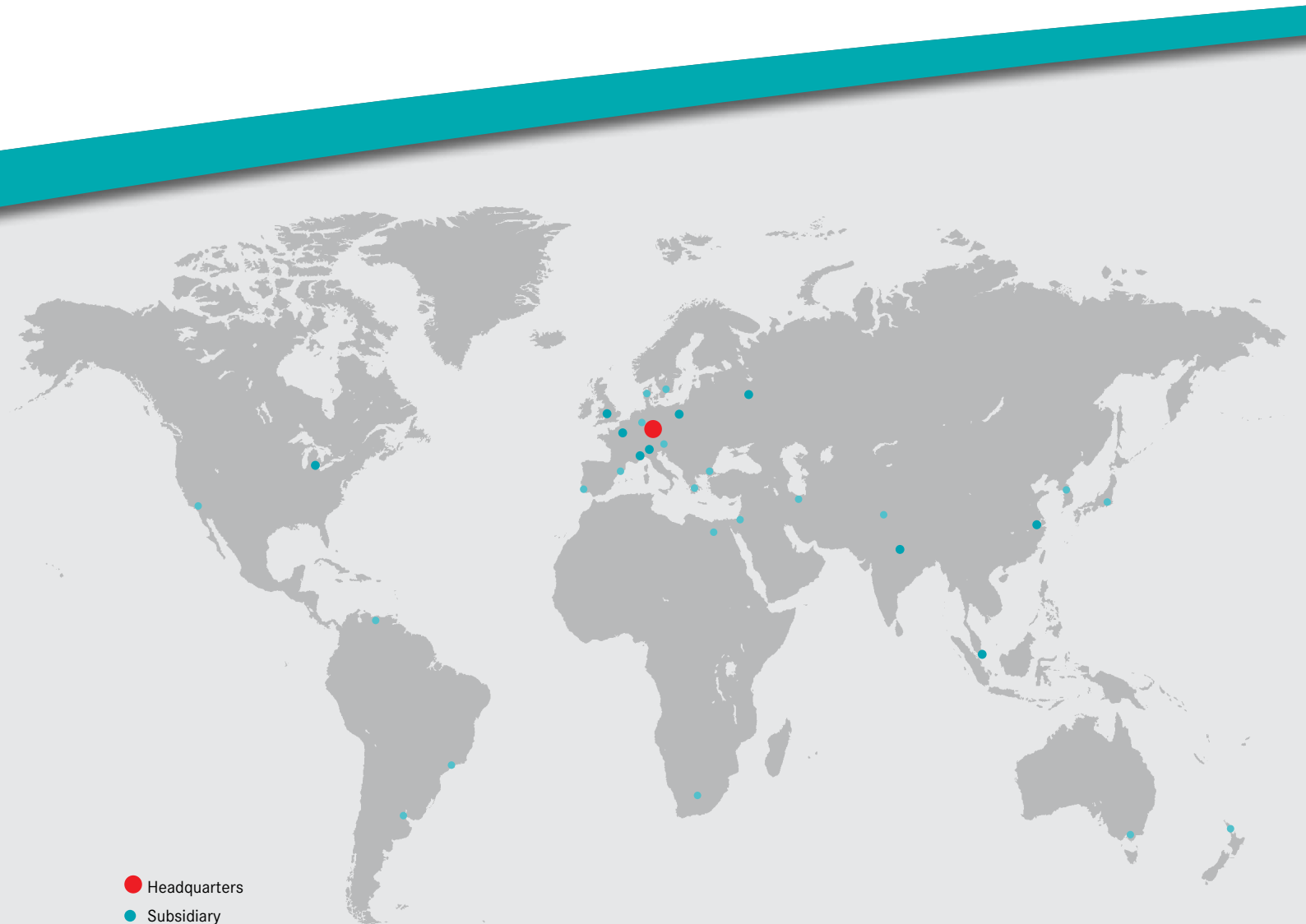

- Headquarters
- Subsidiary
- Service and Sales Partner

WENZEL®

The company of μ

WENZEL PRÄZISION GmbH
D-97859 Wiesthal
Phone: +49 6020 201-0
Fax: +49 6020 201-1999
info@wenzel-group.com
www.wenzel-group.com

